



Non-destructive testing of steel forgings—

Part 4: Ultrasonic testing of austenitic and austenitic-ferritic stainless steel forgings

The European Standard EN 10228-4:1999 has the status of a
British Standard

ICS 77.040.20; 77.140.85



National foreword

This British Standard is the English language version of EN 10228-4:1999. Together with BS EN 10228-3:1998 it supersedes BS 4124:1991, which is withdrawn.

The UK participation in its preparation was entrusted by Technical Committee ISE/73, Steels for pressure purposes, to Subcommittee ISE/73/3, Steel forgings for pressure purposes, which has the responsibility to:

- aid enquirers to understand the text;
- present to the responsible European committee any enquiries on the interpretation, or proposals for change, and keep the UK interests informed;
- monitor related international and European developments and promulgate them in the UK.

A list of organizations represented on this subcommittee can be obtained on request to its secretary.

Cross-references

The British Standards which implement international or European publications referred to in this document may be found in the BSI Standards Catalogue under the section entitled "International Standards Correspondence Index", or by using the "Find" facility of the BSI Standards Electronic Catalogue.

A British Standard does not purport to include all the necessary provisions of a contract. Users of British Standards are responsible for their correct application.

Compliance with a British Standard does not of itself confer immunity from legal obligations.

Summary of pages

This document comprises a front cover, an inside front cover, the EN title page, pages 2 to 24, an inside back cover and a back cover.

The BSI copyright notice displayed in this document indicates when the document was last issued.

Amendments issued since publication

Amd. No.	Date	Comments
13204 Amendment No. 1	September 2001	Addition of supersession details

This British Standard, having been prepared under the direction of the Engineering Sector Committee, was published under the authority of the Standards Committee and comes into effect on 15 December 1999

© BSI 08-2001

EUROPEAN STANDARD

EN 10228-4

NORME EUROPÉENNE

EUROPÄISCHE NORM

August 1999

ICS 77.040.20; 77.140.85

English version

Non-destructive testing of steel forgings - Part 4: Ultrasonic testing of austenitic and austenitic-ferritic stainless steel forgings

Essais non destructifs des pièces forgées en aciers -
Partie 4: Contrôle par ultrasons des pièces forgées en
aciers inoxydables austénitiques et austéno-ferritiques

Zerstörungsfreie Prüfung von Schmiedestücken aus Stahl -
Teil 4: Ultraschallprüfung von Schmiedestücken aus
austenitischem und austenitisch-ferritischem
nichtrostendem Stahl

This European Standard was approved by CEN on 9 July 1999.

CEN members are bound to comply with the CEN/GENELEC Internal Regulations which stipulate the conditions for giving this European Standard the status of a national standard without any alteration. Up-to-date lists and bibliographical references concerning such national standards may be obtained on application to the Central Secretariat or to any CEN member.

This European Standard exists in three official versions (English, French, German). A version in any other language made by translation under the responsibility of a CEN member into its own language and notified to the Central Secretariat has the same status as the official versions.

CEN members are the national standards bodies of Austria, Belgium, Czech Republic, Denmark, Finland, France, Germany, Greece, Iceland, Ireland, Italy, Luxembourg, Netherlands, Norway, Portugal, Spain, Sweden, Switzerland and United Kingdom.



EUROPEAN COMMITTEE FOR STANDARDIZATION
COMITÉ EUROPÉEN DE NORMALISATION
EUROPÄISCHES KOMITEE FÜR NORMUNG

Central Secretariat: rue de Stassart, 36 B-1050 Brussels



Contents

	Page
Foreword	3
1 Scope	4
2 Normative references	4
3 Definitions	5
4 Items for agreement	5
5 Written procedure	5
6 Personnel qualification	6
7 Equipment and accessories	6
8 Routine calibration and checking	8
9 Stage of manufacture	8
10 Surface condition	8
11 Sensitivity	9
12 Scanning	10
13 Classification	14
14 Recording levels and acceptance criteria	18
15 Sizing	21
16 Reporting	21
Annex A (informative) Maximum testable depth for circumferential shear wave scans	22
Annex B (informative) dB amplitude of indication relative to % DAC	23
Annex Z (informative) Clauses of this European Standard addressing essential requirements or other provisions of EU Directives.	24



Foreword

This European Standard has been prepared by Technical Committee ECISS/TC 28, Steel forgings, the Secretariat of which is held by BSI.

This European Standard shall be given the status of a national standard, either by publication of an identical text or by endorsement, at the latest by February 2000, and conflicting national standards shall be withdrawn at the latest by February 2000.

This European Standard has been prepared under a mandate given to CEN by the European Commission and the European Free Trade Association. This European Standard is considered to be a supporting standard to those application and product standards which in themselves support an essential safety requirement of a New Approach Directive and which make reference to this European Standard.

The titles of the parts of this European Standard are:

Part 1: Magnetic particle inspection;

Part 2: Penetrant testing;

Part 3: Ultrasonic testing of ferritic and martensitic steel forgings;

Part 4: Ultrasonic testing of austenitic and austenitic-ferritic stainless steel forgings.

According to the CEN/CENELEC Internal Regulations, the national standards organizations of the following countries are bound to implement this European Standard: Austria, Belgium, Czech Republic, Denmark, Finland, France, Germany, Greece, Iceland, Ireland, Italy, Luxembourg, Netherlands, Norway, Portugal, Spain, Sweden, Switzerland and the United Kingdom.

1 Scope

This part of EN 10228 specifies methods for the manual, pulse-echo, ultrasonic testing of forgings manufactured from austenitic and austenitic-ferritic stainless steels. Mechanized scanning techniques, such as immersion testing, may be used but should be agreed between the purchaser and supplier.

This part of EN 10228 applies to four types of forgings, classified according to their shape and method of production. Types 1, 2 and 3 are essentially simple shapes. Type 4 covers complex shapes.

This part of EN 10228 does not apply to:

- rolled bars;
- closed die forgings;
- turbine rotor and generator forgings.

Ultrasonic testing of ferritic and martensitic steel forgings is the subject of part 3 of this European Standard.

2 Normative references

This part of EN 10228 incorporates, by dated or undated reference, provisions from other publications. These normative references are cited at the appropriate places in the text and the publications are listed hereafter. For dated references, subsequent amendments to or revisions of any of these publications apply to this part of EN 10228 only when incorporated in it by amendment or revision. For undated references the latest edition of the publication referred to applies.

EN 473	Qualification and certification of NDT personnel
prEN 583-2	Non-destructive testing - Ultrasonic examination - Part 2: Sensitivity and range setting
prEN 583-5	Non-destructive testing - Ultrasonic examination - Part 5: Characterization and sizing of discontinuities
EN 1330-1	Non destructive testing -Terminology - Part 1: List of general terms
prEN 1330-4	Non destructive testing - Terminology - Part 4: Terms used in ultrasonic testing
prEN 12223	Ultrasonic examination - Calibration blocks

- prEN 12668-1 Non-destructive testing - Characterization and verification of ultrasonic examination equipment - Part 1: Instruments
- prEN 12668-2 Non-destructive testing - Characterization and verification of ultrasonic examination equipment - Part 2: Probes
- prEN 12668-3 Non-destructive testing - Characterization and verification of ultrasonic examination equipment - Part 3: Combined equipment

3 Definitions

The definitions given in EN 1330-1 and prEN 1330-4 apply.

4 Items for agreement

The following aspects concerning ultrasonic testing shall be agreed between the purchaser and supplier at the time of the enquiry or order:

- a) the volume(s) to be tested and whether grid scanning coverage or 100 % scanning coverage is required (see clause 12);
- b) whether near surface examination is required (see **7.2.6**);
- c) the quality class required, or the quality classes and the zones to which they apply (see clause 14);
- d) whether any special scanning coverage, equipment or couplant is required in addition to that detailed in clauses 7 and 12;
- e) the scanning technique to be used if not manual (see clause 1);
- f) the sizing techniques to be used for extended discontinuities (see clause 15);
- g) the technique(s) to be used for setting sensitivity (see clause 11);
- h) whether the test is to be conducted in the presence of the purchaser or his representative;
- i) whether a written procedure shall be submitted for approval by the purchaser (see clause 5);
- j) whether examination by shear wave probes is required (see **11.3**);
- k) the remaining examination requirements for complex forgings (type 4) (see **12.2**).

5 Written procedure

Ultrasonic testing shall be performed in accordance with a written procedure. Where specified in the enquiry or order, the written procedure shall be submitted to the purchaser for approval prior to testing.

This written procedure shall be in the form of:

- a product specification; or
- a procedure written specifically for the application; or
- this part of EN 10228 may be used if it is accompanied by examination details specific to the application.

The written procedure shall contain the following details as a minimum requirement:

- a) description of the item to be examined;
- b) reference documents;
- c) qualification and certification of examination personnel;
- d) stage of manufacture at which the examination is carried out;
- e) examination zones specified in terms of the applicable quality classes;
- f) preparation of scanning surfaces;
- g) couplant;
- h) description of examination equipment;
- i) calibration and settings;
- j) scanning plan;
- k) description and sequence of examination operations;
- l) recording levels;
- m) characterization of discontinuities;
- n) acceptance criteria;
- o) examination report.

6 Personnel qualification

Personnel shall be qualified and certificated in accordance with the requirements detailed in EN 473.

7 Equipment and accessories

7.1 Flaw detector

The flaw detector shall feature A-scan presentation and shall conform to the requirements of prEN 12668-1.



7.2 Probes

7.2.1 General

Probes used for the initial detection of defects shall conform to prEN 12668-2. Where supplementary probes are used for purposes other than the initial detection of defects, they need not conform to prEN 12668-2.

7.2.2 Contouring

When required, probes shall be contoured in accordance with prEN 583-2.

7.2.3 Nominal frequency

Probes shall have a nominal frequency in the range from 0,5 MHz to 6 MHz.

7.2.4 Normal probes

Effective crystal diameter shall be in the range from 10 mm to 40 mm.

7.2.5 Shear wave probes

Shear wave probe beam angles shall be in the range from 35° to 70°.

Effective crystal area shall be in the range from 20 mm² to 625 mm².

7.2.6 Twin crystal probes

If near-surface examination is required, then twin crystal probes shall be used.

7.3 Calibration blocks

Calibration blocks shall conform to the requirements detailed in prEN 12223.

7.4 Reference blocks

Reference blocks shall be used when sensitivity is to be established by the distance amplitude curve (DAC) technique and/or when defects are to be sized in terms of amplitude relative to reference reflectors by the DAC technique. The surface condition of the reference block shall be representative of the surface condition of the part to be examined. Unless otherwise specified, the reference block shall contain at least three reflectors covering the entire depth range under examination.

The reference block shall be manufactured from one of the following:

- a) an excess length of the part to be examined, or

- b) a part of the same material and with the same heat treatment condition as the part to be examined; or
- c) a part having similar acoustic properties to the part to be examined.

Reference blocks shall not be used for the distance gain size (DGS) technique other than for checking the accuracy of a particular DGS diagram.

NOTE Different sizes of reflectors from those detailed in Tables 5 and 6 may be used as long as the test sensitivity is corrected accordingly.

7.5 Couplant

The same type of couplant shall be used for calibration, setting sensitivity, scanning and defect assessment.

NOTE Examples of suitable couplants are: water (with or without corrosion inhibitor or softener), grease, oil, glycerol and water-cellulose paste.

After examination, couplant shall be removed if its presence could adversely affect later manufacturing or inspection operations or the integrity of the component.

8 Routine calibration and checking

The combined equipment (flaw detector and probes) shall be calibrated and checked in accordance with the requirements detailed in prEN 12668-3.

9 Stage of manufacture

Ultrasonic testing shall be performed after the final quality heat treatment or at the latest stage of manufacture at which the required ultrasonic coverage can be achieved.

NOTE For both cylindrical and rectangular forgings which are to be bored, it is recommended to carry out ultrasonic testing before boring.

10 Surface condition

10.1 General

Surfaces to be scanned shall be free from paint, non-adhering scale, dry couplant, surface irregularities or any other substance which could reduce coupling efficiency, hinder the free movement of the probe or cause errors in interpretation.



10.2 Surface finish related to quality class

In the machined condition, for testing to quality classes 1 and 2, a surface finish corresponding to a roughness $R_a \leq 12,5 \mu\text{m}$ shall be produced and for testing of quality class 3, a surface finish corresponding to a roughness $R_a \leq 6,3 \mu\text{m}$ shall be produced.

10.3 As-forged surface condition

Where forgings are supplied in the as-forged surface condition they shall be considered acceptable providing the specified quality class can be achieved. When it is not practical to perform a comprehensive examination on as-forged surfaces, shot blasting, sand blasting or surface grinding shall be used to ensure that acoustic coupling can be maintained.

NOTE Only quality class 1 is normally applicable.

11 Sensitivity

11.1 General

Sensitivity shall be sufficient to ensure the detection of the smallest discontinuities required by the recording levels (see Table 4 and when required, Tables 5 or 6). If the required sensitivity cannot be achieved due to coarse grain size, acceptance of the forging shall be subject to agreement between the purchaser and supplier.

11.2 Normal probes

For normal probes, one of the following techniques shall be used to establish sensitivity for scanning:

- a) distance amplitude curve (DAC) technique, based upon the use of flat bottomed holes;
- b) distance gain size (DGS) technique.

The procedure to be used in each case shall be in accordance with prEN 583-2.

11.3 Shear-wave probes (see 4j)

For shear-wave probes, one of the following techniques shall be used to establish sensitivity for scanning:

- a) DAC technique using 3 mm diameter side-drilled holes;
- b) DGS technique.

The procedure to be used in each case shall be as detailed in prEN 583-2.

The DAC and DGS techniques shall not be compared for shear wave probes.

11.4 Repeat inspection

Where repeat inspection is performed, the same method of establishing sensitivity (DAC or DGS) shall be used as was initially used.

12 Scanning

12.1 General

Scanning shall be performed using the manual contact pulse-echo techniques.

The minimum scanning coverage required is dictated by the type of forging and whether grid scanning coverage or 100 % scanning coverage has been specified in the enquiry or order.

Table 1 classifies four types of forging according to their shapes and method of production.

Scanning coverage of forging types 1, 2 and 3 with normal probes shall be as given in Table 2.

Scanning coverage with shear-wave probes for forging types 3a and 3b which have outside diameter to inside diameter ratio of less than 1,6:1 shall be as given in Table 3. The effective depth of circumferentially orientated shear wave scans is limited by the probe angle and the forging diameter (see annex A).

12.2 Complex forgings

For complex shaped forgings or complex shaped parts of forgings (type 4) and small diameter forgings, examination shall include, as a minimum, the required probe angles, scanning directions and extent of scanning coverage (grid or 100 %). The remaining requirements shall be agreed between purchaser and supplier (see **4k**).

12.3 Grid scanning coverage

Grid scanning shall be performed with the probe or probes traversed along the grid lines defined in Tables 2 and 3.

Where recordable indications are revealed by grid scanning, additional scanning shall be performed to determine the extent of the indications.

12.4 100 % scanning coverage

100 % scanning coverage shall be performed over the surfaces specified in Tables 2 and 3. Consecutive probe traverses shall overlap by at least 10 % of the effective probe diameter.

12.5 Scanning speed

Manual scanning speed shall not exceed 150 mm/s.

Table 1: Classification of forgings according to their shape and method of production

Type	Shape	Method of production
1a ¹⁾	<p>Elongated with round or approximately round section, e.g. bars, rods, cylinders, shafts, journals, discs cut from bars</p> 	Direct forged
1b ¹⁾	<p>Elongated with rectangular or approximately rectangular section, e.g. bars, rods, blocks, sections cut from bars</p> 	
2 ²⁾	<p>Flattened, e.g. discs, plate, flywheels</p> 	Upset



Table 1: Classification of forgings according to their shape and method of production (Continued)

Type	Shape	Method of production
3a	Hollow cylindrical shapes, e.g. bottles compressed gas tanks 	Mandrel forged
3b	Hollow cylindrical shapes, e.g. rings, flanges, rims 	Expanded
3c		Circular laminating
4	All forgings or parts of forgings with complex shape	At the manufacturer's discretion
1) Type 1 forgings may incorporate bores of small diameter relative to the major dimensions 2) Type 2 forgings may eventually be drilled (e.g. binding discs)		

Table 2: Scanning coverage with normal probes

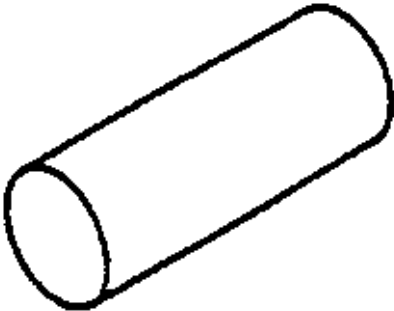
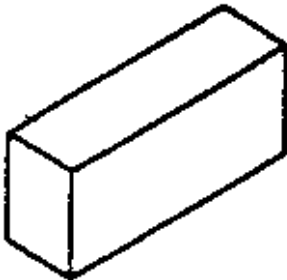
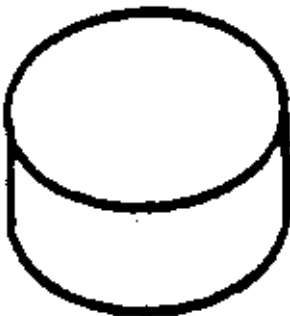



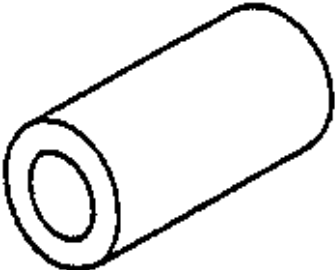
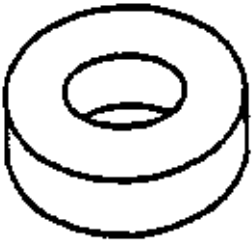

Type		Grid scanning ¹⁾		100 % scanning ¹⁾²⁾
1	1a	Diameter, D (mm)	Scan lines ³⁾	Scan 100 % around at least 180° of cylindrical surface
		$D \leq 200$ $200 < D \leq 500$ $500 < D \leq 1000$ $1000 < D$	2 at 90° 3 at 60° 4 at 45°	
	1b	Scan along the lines of a square-link grid on two perpendicular surfaces ³⁾⁴⁾		Scan 100 % on two perpendicular surfaces
				
2		Scan along the lines of a square-link grid around 360° on the cylindrical surface and one lateral surface ⁴⁾		Scan 100 % around at least 180° on the cylindrical surface and 100 % of one lateral surface
3	3a	Scan along the lines of a square-link grid around 360° on the outer cylindrical surface ⁴⁾		Scan 100 % around 360° on the outer cylindrical surface
				
	3b & 3c	Scan along the lines of a square-link grid around 360° on the outer cylindrical surface and one lateral surface ¹⁾		Scan 100 % around 360° on the outer cylindrical surface and one lateral surface
				
4	Scanning coverage shall be specified in the enquiry or order			
¹⁾ Additional scanning (for example, in both axial directions for type 3a) may be carried out if specified in the enquiry or order ²⁾ 100 % means at least 10 % probe overlap between consecutive probe traverses ³⁾ For types 1a or 1b, if the presence of a bore prevents the opposite surface being reached, the number of scan lines shall be doubled symmetrically ⁴⁾ The grid line separation shall be equal to the part thickness up to a maximum of 200 mm				

Table 3: Scanning coverage with shear wave probes

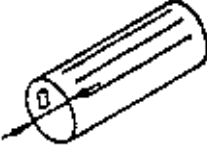
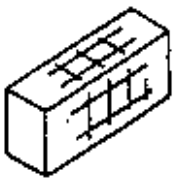
Type		Grid scanning ¹⁾	100 % scanning ¹⁾²⁾
3	<p>3a</p>  <p>3b</p> 	Scan in both directions along 360° circumferential grid lines, the separation of which is equal to the radial thickness up to a maximum of 200 mm	Scan in both circumferential directions over 100 % on the outer cylindrical surface ²⁾
4	Scanning coverage shall be specified in the enquiry or order		
<p>¹⁾ Additional scanning coverage may be carried out if specified in the enquiry or order</p> <p>²⁾ 100 % means at least 10 % probe overlap between consecutive probe traverses</p>			

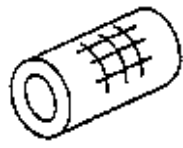
13 Classification

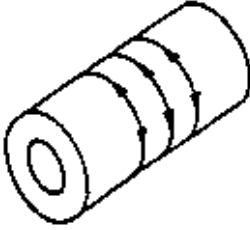
13.1 Classification of indications

Where practicable classification of indications according to their echodynamic pattern shall be made by scanning from a minimum of two mutually perpendicular directions.

a) Pattern 1

As the probe is moved, the A-scan display shows a single sharp indication rising smoothly in amplitude to a maximum and then falling smoothly to zero (see Figure 1a).

This A-scan display in combination with the echodynamic pattern in Figure 1b obtained from the side-drilled holes used to plot the beam profile, corresponds to discontinuity dimensions smaller than or equal to the -6 db beam profile.

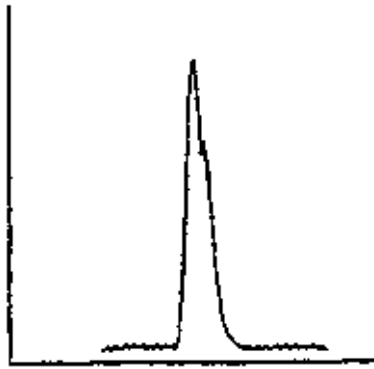

Figure 1a: A-scan presentation
(at typical probe position)

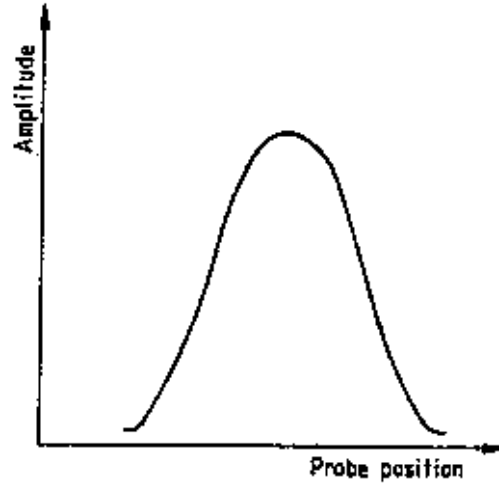

Figure 1b: Echodynamic pattern
(variation in signal amplitude as probe is moved)

Figure 1: Pattern 1 A-scan presentation and echo envelope presentation

b) Pattern 2

As the probe is moved, the A-scan display shows a single sharp indication rising smoothly in amplitude to a maximum and then falling smoothly to zero (see Figure 2a). This A-scan display in combination with the echodynamic pattern in Figure 2b obtained from the side-drilled holes used to plot the beam profile, corresponds to discontinuity dimensions greater than the to -6 dB beam profile.

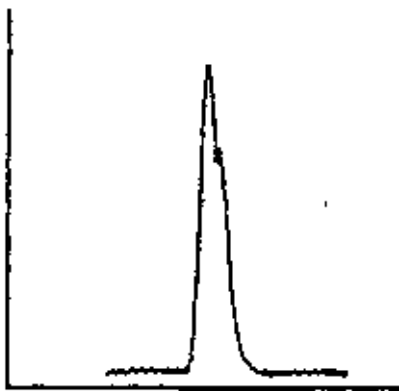

Figure 2a: A-scan presentation
(at typical probe position)

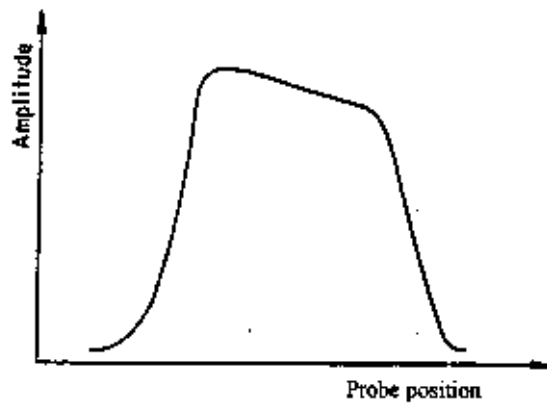

Figure 2b: Echodynamic pattern
(variation in signal amplitude as probe is moved)

Figure 2: Pattern 2 A-scan presentation and echo envelope presentation

13.2 Classification of discontinuities

Discontinuities shall be classified according to their echodynamic patterns as follows:

a) **Point discontinuity**

Echodynamic pattern 1 and/or dimension equal to or less than the -6 dB beam width (see Figure 3a).

b) **Extended discontinuity**

Echodynamic pattern 2 and/or dimension greater than the -6 dB width (see Figure 3b).

c) **Isolated discontinuities**

The distance d , between points corresponding to the maxima of the indications of adjacent discontinuities exceeds 40 mm (see Figure 3c).

d) **Grouped discontinuities**

The distance d , between points corresponding to the maxima of the indications of adjacent discontinuities is less than or equal to 40 mm (see Figure 3d).

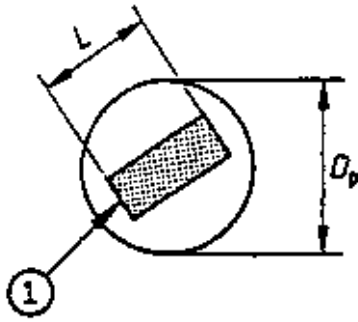

Figure 3a: Point discontinuity
($L \leq D_p$)

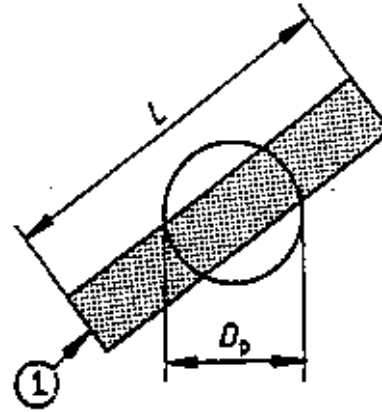

Figure 3b: Extended discontinuity
($L > D_p$)

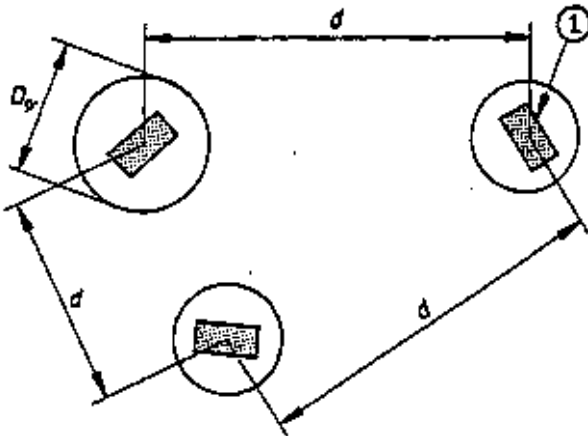

Figure 3c: Isolated point discontinuities
($L \leq D_p$, $d > 40$ mm)

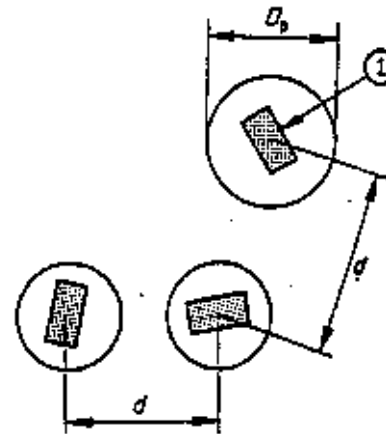
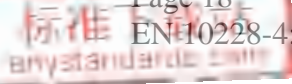

Figure 3d: Grouped point discontinuities
($L \leq D_p$, $d \leq 40$ mm)

Symbols used:

- 1 Conventional outline of -6 dB discontinuity
- D_p Width of beam at depth of discontinuity
- d Distance between two discontinuities
- L Conventional length of -6 dB discontinuity

Figure 3: Classification of discontinuities



14 Recording levels and acceptance criteria

Several quality classes may be applied to a forging or to parts of a forging. The applicable quality class(es) shall be agreed between the purchaser and supplier. Table 4 details recording levels and acceptance criteria which shall be applied to three quality classes for normal probes. Tables 5 and 6 detail recording levels and acceptance criteria which shall be applied for shear waves.

Table 4: Quality classes recording and acceptance criteria for normal probes¹⁾

Forging thickness t mm	Recording level $d_{eq}^{2)}$ mm	Acceptance criteria for	
		Isolated discontinuities $d_{eq}^{2)}$ mm	Extended or grouped discontinuities $d_{eq}^{2)}$ mm
Quality class 1			
$t \leq 75$	> 5	≤ 8	≤ 5
$75 < t \leq 250$	> 8	≤ 11	≤ 8
$250 < t \leq 400$	> 14	≤ 19	≤ 14
$t > 400$	Indication with a 80 % reduction of backwall echo	Indication with a total loss of backwall echo. A total loss of backwall echo is to be considered when its amplitude becomes less than 5 % of its initial value measured near the indication or less than or equal to grass	
Quality class 2			
$t \leq 75$	> 3	≤ 5	≤ 3
$75 < t \leq 250$	> 5	≤ 8	≤ 5
$250 < t \leq 400$	> 8	≤ 11	≤ 8
$400 < t \leq 600$	> 11	≤ 15	≤ 11
$t > 600$	Indication with a 80 % reduction of backwall echo	Indication with a total loss of backwall echo. A total loss of backwall echo is to be considered when its amplitude becomes less than 5 % of its initial value measured near the indication or less than or equal to grass	
Quality class 3			
$t < 75$	> 2	≤ 3	≤ 2
$75 < t \leq 250$	> 3	≤ 5	≤ 3
$250 < t \leq 400$	> 5	≤ 8	≤ 5
$400 < t \leq 600$	> 8	≤ 11	≤ 8
$t > 600$	Indication with a 80 % reduction of backwall echo	Indication with a total loss of backwall echo. A total loss of backwall echo is to be considered when its amplitude becomes less than 5 % of its initial value measured near the indication or less than or equal to grass	
¹⁾ Reflector diameter shall not be interpreted as representing the dimension of the discontinuity which caused the echo. ²⁾ d_{eq} = Equivalent diameter of flat-bottomed hole.			

Table 5: Recording and acceptance criteria for shear waveprobes for DGS techniques

Forging thickness <i>t</i> mm	Recording level <i>d_{eq}</i> ¹⁾ mm	Acceptance criteria for	
		Isolated discontinuities <i>d_{eq}</i> mm	Extended or grouped discontinuities <i>d_{eq}</i> mm
$t \leq 75$	> 3	≤ 5	≤ 3
$75 < t \leq 250$	> 5	≤ 8	≤ 5
$250 < t \leq 400$ ²⁾	> 8	≤ 11	≤ 8

¹⁾ *d_{eq}* = Equivalent diameter of flat bottomed hole.
²⁾ For thicknesses > 400 mm testing shall be as agreed between purchaser and supplier.

Table 6: Recording and acceptance criteria for shear wave probes for DAC technique¹⁾²⁾³⁾

Forging thickness mm	Nominal test frequency MHz	Recording level %	Acceptance criteria for	
			Isolated discontinuities %	Extended or grouped discontinuities %
$t \leq 75$	1	30	60	30
	2	50	100	50
$75 < t \leq 250$	1	50	100	50
	2	100	200	100
$250 < t \leq 400$	1	100	200	100
	2	200	400	200

¹⁾ Based on 3 mm diameter side-drilled holes.
²⁾ A DAC based on 3 mm diameter side drilled holes shall be constructed for each frequency of probe used.
³⁾ The indication amplitude in dB, relative to the DAC, is given in annex B.



15 Sizing

Where the extent of a discontinuity is required to be evaluated, one or more of the following techniques, as agreed between the purchaser and the supplier, shall be used. These techniques shall be carried out in accordance with the requirements detailed in prEN 583-5.

- a) 6 db drop tip location technique;
- b) 20 db drop tip location technique;
- c) beam axis tip location technique.

16 Reporting

All tests shall be the subject of a written report which shall include the following information as a minimum requirement:

- a) name of supplier;
- b) order number;
- c) identification of forging(s) under examination;
- d) scope of examination: examination zones and applicable quality classes;
- e) stage of manufacture at which ultrasonic testing was performed;
- f) surface condition;
- g) equipment used
- h) technique(s) used to set sensitivity;
- i) reference to this standard and, if applicable, reference to the written procedure used;
- j) results of examination: location, classification and amplitude (in terms of FBH-equivalent diameter, or in percent of SDH) of all discontinuities exceeding the appropriate recording level;
- k) details of any restrictions to the required scanning coverage and if applicable the extent of the near surface zone;
- l) date of examination;
- m) name, qualification and signature of operator.

Annex A (informative)

Maximum testable depth for circumferential shear wave scans

Maximum testable depths (see Figure A.1) for circumferential shear-wave scans, for various probe angles and outside radii, are given in Table A.1.

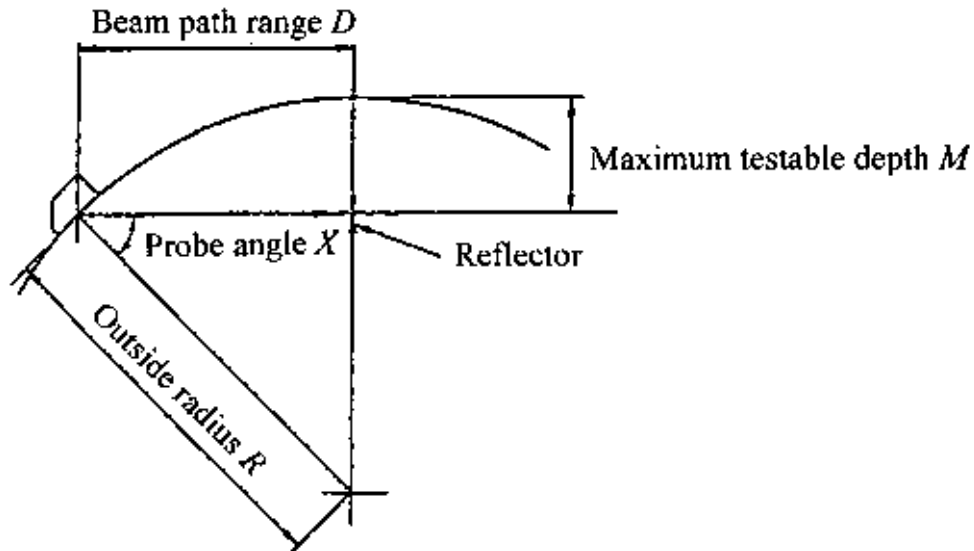

Figure A.1: Maximum testable depth for circumferential shear wave scans

D is the beam path range for normal incidence on a radial reflector

M is the maximum testable depth for a particular probe angle and outside radius R

Table A.1: Maximum testable depths for circumferential shear-wave scans

Probe angle X	Maximum test depth, M	Beam path range, D
70°	0,06R	0,34R
60°	0,13R	0,50R
50°	0,24R	0,64R
45°	0,30R	0,70R
35°	0,42R	0,82R

NOTE The maximum testable depth and beam path range to maximum testable depth, are given in terms of the outside radius R , of the forging for radial reflectors. The beam path range, D , values shown can effectively be doubled.



Annex B (informative)

dB amplitude of indication relative to % DAC

As an alternative to constructing a DAC which is a percentage of the 3 mm diameter side drilled hole DAC (100 % DAC), the required recording/acceptance level may be achieved by constructing the 3 mm DAC (100 % DAC) and adjusting the amplitude according to Table B.1.

Table B.1: dB amplitude relative to % DAC

DAC %	Amplitude of indication relative to DAC dB
25	-12
30	-10
50	-6
60	-4
100	0
200	+6
400	+12

Annex Z (informative)

Clauses of this European Standard addressing essential requirements or other provisions of EU Directives.

This European Standard has been prepared under a mandate given to CEN by the European Commission and supports essential requirements of EU Directive 97/23/EC.

Warning: Other requirements and other EU Directives may be applicable to the product(s) falling within the scope of this European Standard.

The clauses of this European Standard are likely to support the essential requirements of section 4 of annex 1, “Essential safety requirements” of the Pressure Equipment Directive 97/23/EC.

Compliance with this European Standard provides one means of conforming with the specific essential requirements of the Directive concerned.



BSI – British Standards Institution

BSI is the independent national body responsible for preparing British Standards. It presents the UK view on standards in Europe and at the international level. It is incorporated by Royal Charter.

Revisions

British Standards are updated by amendment or revision. Users of British Standards should make sure that they possess the latest amendments or editions.

It is the constant aim of BSI to improve the quality of our products and services. We would be grateful if anyone finding an inaccuracy or ambiguity while using this British Standard would inform the Secretary of the technical committee responsible, the identity of which can be found on the inside front cover. Tel: 020 8996 9000. Fax: 020 8996 7400.

BSI offers members an individual updating service called PLUS which ensures that subscribers automatically receive the latest editions of standards.

Buying standards

Orders for all BSI, international and foreign standards publications should be addressed to Customer Services. Tel: 020 8996 9001. Fax: 020 8996 7001. Standards are also available from the BSI website at <http://www.bsi-global.com>.

In response to orders for international standards, it is BSI policy to supply the BSI implementation of those that have been published as British Standards, unless otherwise requested.

Information on standards

BSI provides a wide range of information on national, European and international standards through its Library and its Technical Help to Exporters Service. Various BSI electronic information services are also available which give details on all its products and services. Contact the Information Centre. Tel: 020 8996 7111. Fax: 020 8996 7048.

Subscribing members of BSI are kept up to date with standards developments and receive substantial discounts on the purchase price of standards. For details of these and other benefits contact Membership Administration. Tel: 020 8996 7002. Fax: 020 8996 7001. Further information about BSI is available on the BSI website at <http://www.bsi-global.com>.

Copyright

Copyright subsists in all BSI publications. BSI also holds the copyright, in the UK, of the publications of the international standardization bodies. Except as permitted under the Copyright, Designs and Patents Act 1988 no extract may be reproduced, stored in a retrieval system or transmitted in any form or by any means – electronic, photocopying, recording or otherwise – without prior written permission from BSI.

This does not preclude the free use, in the course of implementing the standard, of necessary details such as symbols, and size, type or grade designations. If these details are to be used for any other purpose than implementation then the prior written permission of BSI must be obtained.

If permission is granted, the terms may include royalty payments or a licensing agreement. Details and advice can be obtained from the Copyright Manager. Tel: 020 8996 7070.